

# Service Manual

# THE FISHER<sup>®</sup>

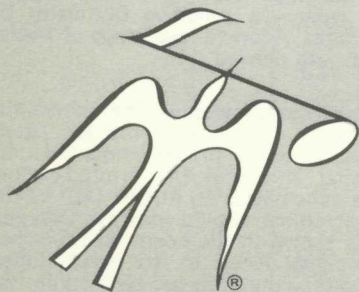
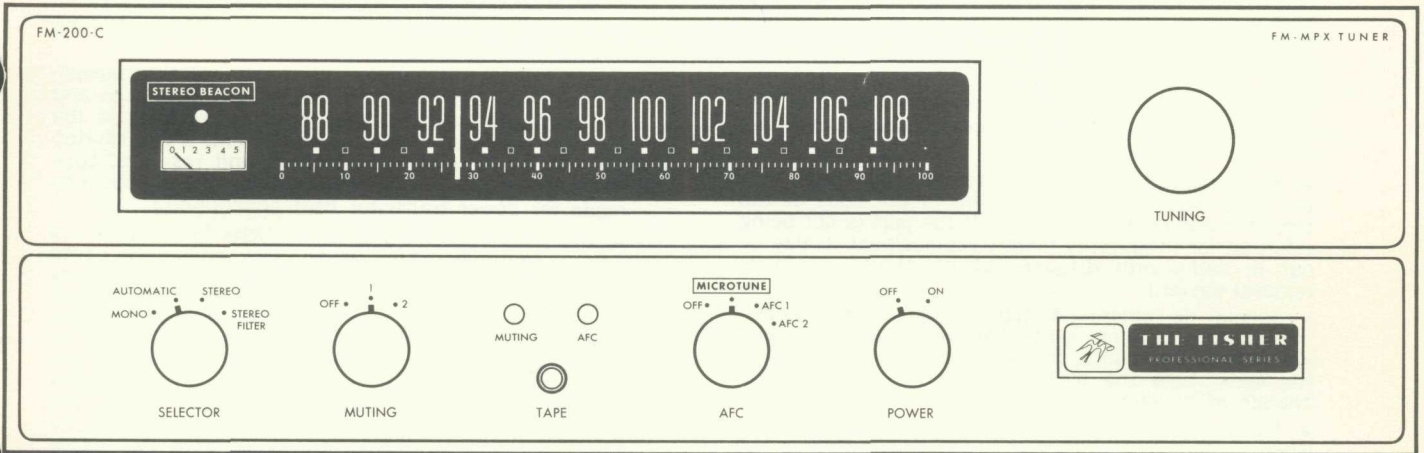

# FM-200-C

CHASSIS SERIAL NUMBERS  
BEGINNING 10001

\$1.00

FISHER RADIO CORPORATION • LONG ISLAND CITY 1 • NEW YORK

**CAUTION:** This is a FISHER precision high-fidelity instrument. It should be serviced only by qualified personnel — trained in the repair of transistor equipment and printed circuitry.

## EQUIPMENT AND TOOLS NEEDED

The following are needed to completely test and align modern high-fidelity instruments such as amplifiers, tuners and receivers.

### Test Instruments

Vacuum-Tube Volt-ohmmeter DC VTVM  
Audio (AC) Vacuum-Tube Voltmeter (AC VTVM)  
Oscilloscope (Flat to 100 kc minimum)  
Audio (Sine-wave) Generator  
Intermodulation Analyzer  
Sweep (FM) Generator (88 to 108 mc)  
Marker Generator  
Multiplex Generator (preferably with RF output — FISHER Model 300 or equal).

### Miscellaneous

Adjustable-Line-Voltage Transformer or line-voltage regulator  
Load Resistors (2) — 8-ohm, 50-watt (or higher)  
Stereo source (Turntable with stereo cartridge or Tape Deck)  
Speakers (2) Full-range, for listening tests  
Soldering iron (with small-diameter tip). Fully insulated from power line.

## PRECAUTIONS

Many of the items below are included just as a reminder — they are normal procedures for experienced technicians. Shortcuts can be taken but often they cause additional damage — to transistors, circuit components or the printed-circuit board.

**Soldering**—A well-tinned, hot, clean soldering iron tip will make it easier to solder without damage to the printed-circuit board or the many many circuit components mounted on it. It is not the wattage of the iron that counts — it is the heat available at the tip. Low-wattage soldering irons will often take too long to heat a connection — pigtail leads will get too hot and damage the part. Too much heat, applied too long, will damage the printed-circuit board. Some 50-watt irons reach temperatures of 1,000° F — others will hardly melt solder. Small-diameter tips should be used for single solder connections — larger pyramid and chisel tips are needed for larger areas.

- When removing defective resistors, capacitors, etc., the leads should be cut as close to the body of the circuit component as possible. (If the part is not being returned for in-warranty factory replacement it may be cut in half — with diagonal-cutting pliers — to make removal easier.)

- Special de-soldering tiptlets are made for unsoldering multiple-terminal units like IF transformers and electrolytic capacitors. By unsoldering all terminals at the same time the part can be removed with little chance of breaking the printed-circuit board.

- Always disconnect the chassis from the power line when soldering. Turning the power switch OFF is not enough. Power-line leakage paths, through the heating element, can destroy transistors.

**Transistors**—Never attempt to do any work on the transistor amplifiers without first disconnecting the AC-power linecord — wait until the power supply filter-capacitors have discharged.

- Guard against shorts — it takes only an instant for a base-to-collector short to destroy that transistor and possibly others direct-coupled to it. [In the time it takes for a dropped machine screw, washer or even the screwdriver, to glance off a pair of socket terminals (or between a terminal and the chassis) a transistor can be ruined.]

- DO NOT bias the base of any transistor to, or near, the same voltage applied to its collector.

- DO NOT use an ohmmeter for testing transistors. The voltage applied through the test probes may be higher than the base-emitter breakdown voltage of the transistor.

**Output Stage and Driver**—Replacements for output and driver transistors, if necessary, must be made from the same beta group as the original type. The beta group is indicated by a colored dot on the mounting flange of the transistor. Be sure to include this information, when ordering replacement transistors.

- If one output transistor burns out (open or shorts), always remove all output transistors in that channel and check the bias adjustment, the control and other parts in the network with an ohmmeter before inserting a new transistor. All output transistors in one channel will be destroyed if the base-biasing circuit is open on the emitter end.

- When mounting a replacement power transistor be sure the bottom of the flange, the mica insulator and the surface of the heat sink are free of foreign matter. Dust and grit can prevent perfect contact. This reduces heat transfer to the heat sink. Metallic particles can puncture the insulator and cause shorts — ruining the transistor.

- Silicone grease must be used between the transistor and the mica insulator and between the mica and the heat sink for best heat conduction. Heat is the greatest enemy of electronic equipment. It can shorten the life of transistors, capacitors and resistors. (Use Dow-Corning DC-3 or C20194 or equivalent compounds made for power transistor heat conduction.)

- Use care when making connections to speakers and output terminals. Any frayed wire ends can cause shorts that may burn out the output transistors — they are direct-coupled to the speakers. There is no output transformer — nothing to limit current through the transistors except the fuses. To reduce the possibility of shorts at the speakers, lugs should be used on the exposed ends — at least the ends of the stranded wires should be tinned to prevent frayed wire ends. The current in the speakers and output circuitry is quite high. Any poor contact or small-size wire, can cause power losses in the speaker system. Use 14 or 16 AWG for long runs of speaker-connecting wiring.

**DC-Voltage Measurements**—These basic tests of the transistor circuitry are made without the signal generator. Without any signal input measure the circuit voltages — as indicated on the schematic. The voltage difference between the base and the emitter should be in the millivolt range — a sensitive DC meter is needed for these readings. A low-voltage range of 1 volt, full scale — or lower — is needed.

**Audio-Voltage (gain) Measurements**—The schematic and printed-circuit board layout diagrams are used. Input signals are injected at the proper points — found most quickly by using layout of the printed-circuit board instead of the schematic. An AUDIO (AC) VTVM connected to the test points should indicate voltages close to those values shown in the boxes on the schematic. Many of the signal levels in the input stages are only a few millivolts — they can not be read on the AC ranges supplied on most Vacuum-Tube AC/DC Volt-ohmmeters (VTVMs). Even with a 1-volt range a signal level of 100 millivolts (.1 volt) will be the first 1/10 of the meter scale. A reading of 1 millivolt (.001 volt) will hardly even move the meter needle.

# 966-4 FRONT END

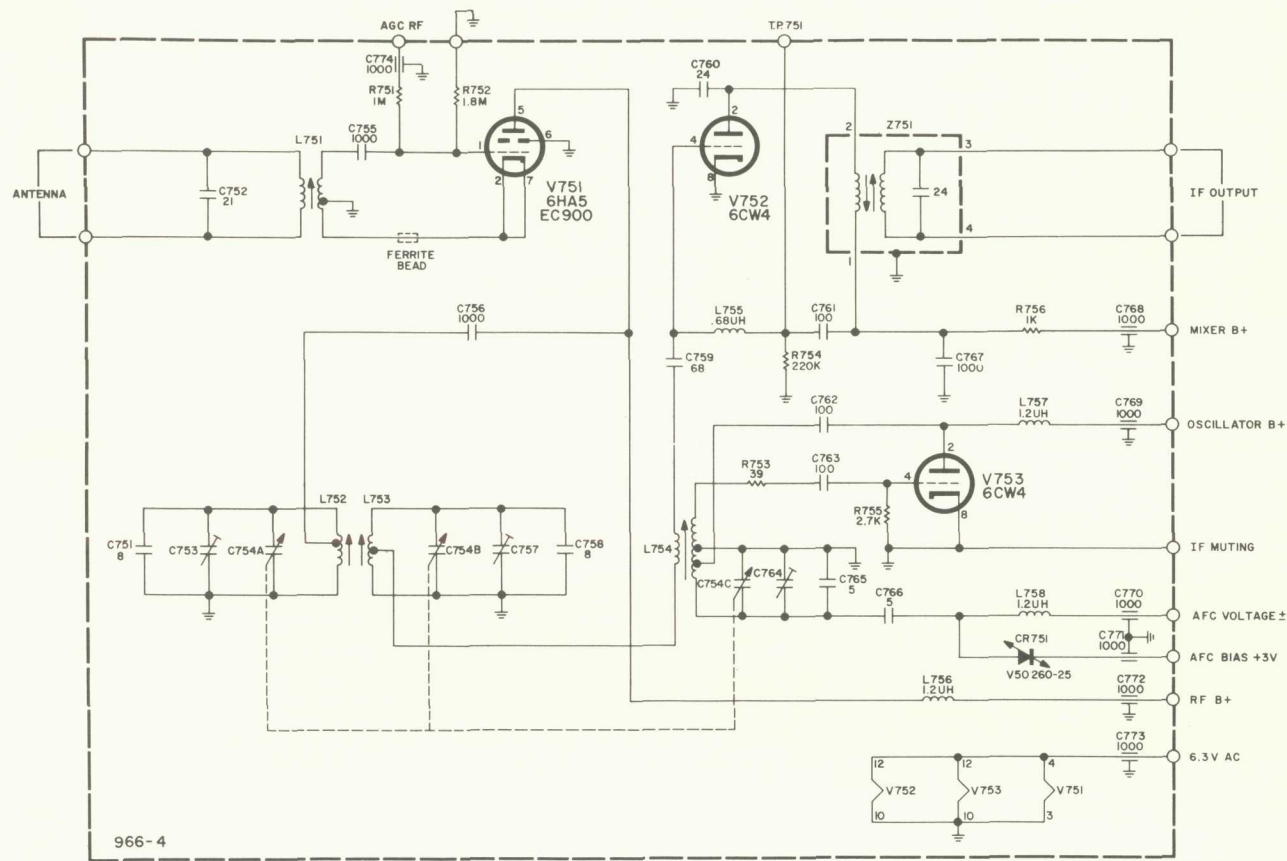

966-4

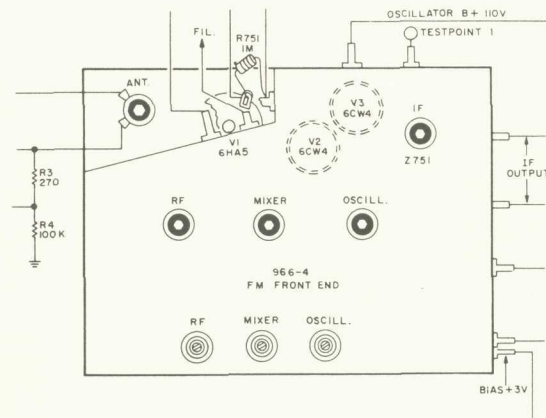

### CAPACITORS

10% Tolerance for all fixed capacitors, unless noted or marked GMV (guaranteed minimum value). All capacitors not marked uF are pF (uF).

Symbol	Description	Part No.
C751	Ceramic, 8, 5%, NPO, 1000V	C50070-45
C752	Ceramic, 21, 5%, N750, 1000V	C50070-32
C753	Trimmer	C662-123
C754A,B,C	Variable, FM Tuning	C966C117-1
C755, 756	Ceramic, 1000, GMV, 500V	C50089-2
C757	Trimmer	C662-123
C758	Ceramic, 8, 5%, NPO, 1000V	C50070-45
C759	Ceramic, 68, 5%, N750, 1000V	C50070-35

C760	Ceramic, 24, 5%, N150, 1000V	C50070-8
C761	Ceramic, 100, 5%, N1500, 1000V	C50070-19
C762, 763	Ceramic, 100, N1500, 1000V	C50070-6
C764	Trimmer	C662-123
C765	Ceramic, 5 ± .25pF, N150, 500V	CC20PG050C
C766	Ceramic, 5 ± .25pF, N080, 500V	CC20LG050C
C767	Ceramic, 1000, 1000V	C50072-3
C768, 769, 770, 771, 772, 773, 774	Ceramic, Feedthru 1000GMV	C592-187

### RESISTORS

Deposited Carbon, in ohms, 5% tolerance 1/8 watt.  
K=Kilohms, M=Megohms.

Symbol	Description	Part No.
R751	1M	R12DC105J
R752	Composition, 1.8M, 10%, 1/2W	RC20BF185K
R753	39	R12DC390J
R754	220K	R12DC224J
R755	2.7K	R12DC272J
R756	1K	R12DC102J

### MISCELLANEOUS

CR751	Diode, Silicon, Varicap	V50260-25
L751	Coil, FM Antenna	L966-113
L752	Coil, FM RF	L1034-113
L753	Coil, FM Mixer	L966-115
L754	Coil, FM Oscillator	AS966-107
L755	Choke, .68 Microhenry	L50066-1
L756, 757, 758	Choke, 1.2 Microhenry	L50066-3
V751	Tube, EC900/6HA5	V-EC900
V752, 753	Nuvistor, 6CW4	V-6CW4
Z751	Transformer, FM IF	ZZ50210-20

### TUNING METER CALIBRATION

- Connect FM generator to the NORMAL antenna terminals through two 120-ohm composition resistors.
- Set generator frequency and tuning dial to 98 mc (generator modulation: ±22.5 kc deviation at 400 cps-10mV output).
- Set tuning-meter calibration control for an indication of 4 on meter.

### SELECTOR-SWITCH POSITION-FUNCTION TESTS

**MONO**—Both monophonic and multiplex-stereo broadcast signals will produce a monophonic signal at the audio outputs.

**AUTOMATIC**—Any FM-broadcast station signal that has a signal of less than 5 uV at the antenna terminals will produce a monophonic signal at the audio outputs. The automatic switching circuits will operate normally when the signal at the antenna terminals is greater than 5 uV and multiplex-stereo broadcasts will then produce stereophonic signals at the audio outputs.

**STEREO**—Only FM stations broadcasting multiplex-stereo programs will produce signals at the audio outputs and only if their signal strength (at the antenna terminals) is greater than 5 uV. Between-station noise will be muted—no output will appear at either the left or right audio outputs. FM stations not broadcasting multiplex-stereo programs will also be muted.

**STEREO FILTER**—Same as AUTOMATIC except that additional circuitry (a high filter) is inserted into the signal audio path to remove annoying high-frequency noises caused by multipath reflections and other forms of interference.

### AUTOMATIC (Stereo) SELECTOR POSITION Test

- Set SELECTOR to the AUTOMATIC position.
- Set MUTING switch to OFF.
- Connect the FM generator to the NORMAL antenna terminals through two 120-ohm composition resistors (see alignment).
- Set generator frequency and tuning dial to 98 mc (external generator modulation: ±6.5 kc deviation at 19 kc-8 uV output).
- Adjust trigger control (on MPX printed-circuit board) to the point where the STEREO BEACON indicator lamp just lights. This point is critical and should be set with care to obtain the normal operation of this circuit.

### MUTING ADJUSTMENT

- Connect Audio (AC) VTVM to left or right output.
- Connect the FM-generator to the NORMAL antenna terminals through two 120-ohm composition resistors.
- Set generator frequency and tuning dial to 98 mc (generator modulation: ±22.5 kc deviation at 400 cps-12 uV output).
- With MUTING off, make note of Audio (AC) VTVM reading.
- Set MUTING switch to position 1, and adjust muting-adjustment control M1 for an Audio (AC) VTVM reading 1 to 5 db less than the reading obtained in the MUTING off position.
- Set generator output to 40 uV.
- With MUTING off, make note of Audio (AC) VTVM reading.
- Set MUTING switch to position 2 and adjust muting-adjustment control M2 for an Audio (AC) VTVM reading 1 to 5 db less than the reading obtained in the MUTING off position.

### AFC and MICROTUNE Tests

- Connect the FM-generator to the NORMAL antenna terminals through two 120-ohm composition resistors.
- Set generator frequency and the tuning dial to 98 mc (generator modulation: ±75 kc deviation at 400 cps-30 uV output).
- Connect scope to right or left audio output.
- With the AFC switch set to OFF adjust tuning knob until dial indicates a frequency slightly lower than 98 mc—until 400 cycle audio signal sine wave on scope becomes distorted.
- Rotate AFC switch to AFC 1 position. Sine wave on scope should reappear—waveform clean and undistorted.
- Repeat steps above for AFC 2 position of AFC switch.
- Repeat steps above for switch positions AFC 1 and AFC 2 with tuning dial set for a frequency slightly higher than 98 mc.
- Set AFC switch to MICROTUNE position.
- Adjust MICROTUNE control (on rear chassis apron) for the most rapid action of the relay when the tuning knob is touched. The AFC should switch "off" automatically as soon as the tuning knob is touched. The AFC action can be observed by watching the 400 cycle sine wave for distortion as above.

NOTE: The MICROTUNE automatic switching action will not occur if the metal dress (front) panel or other metal parts connected to the chassis and the tuning knob are touched at the same time.

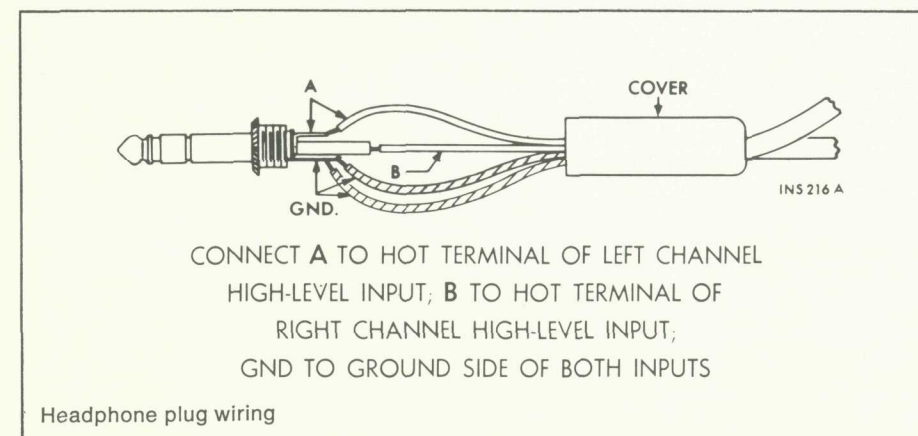

CONNECT A TO HOT TERMINAL OF LEFT CHANNEL  
HIGH-LEVEL INPUT; B TO HOT TERMINAL OF  
RIGHT CHANNEL HIGH-LEVEL INPUT;  
GND TO GROUND SIDE OF BOTH INPUTS

Headphone plug wiring

# 1249 MULTIPLEX DECODER

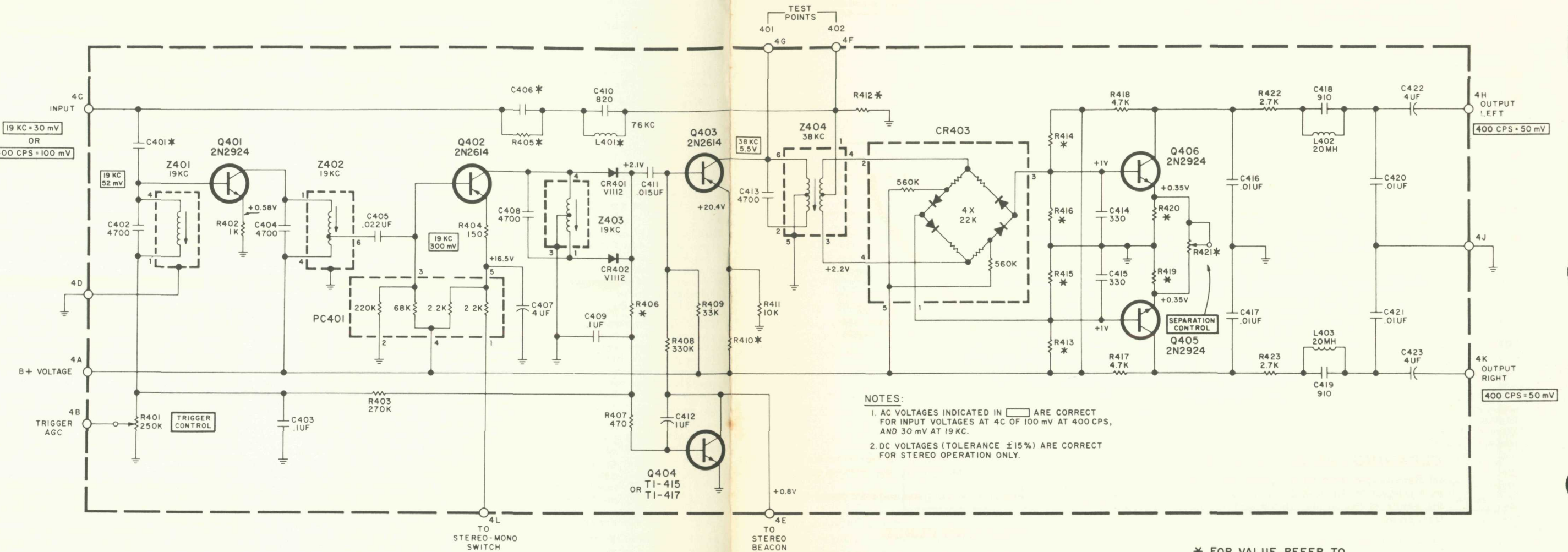

**NOTES:**  
 1. AC VOLTAGES INDICATED IN    ARE CORRECT FOR INPUT VOLTAGES AT 4C OF 100 mV AT 400 CPS, AND 30 mV AT 19 KC.  
 2. DC VOLTAGES (TOLERANCE ±5%) ARE CORRECT FOR STEREO OPERATION ONLY.

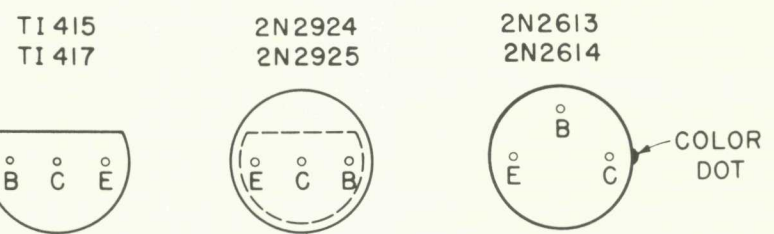

\* FOR VALUE REFER TO PARTS LIST  
 P1249-2  
 AW#2341B

## PARTS DESCRIPTION LIST

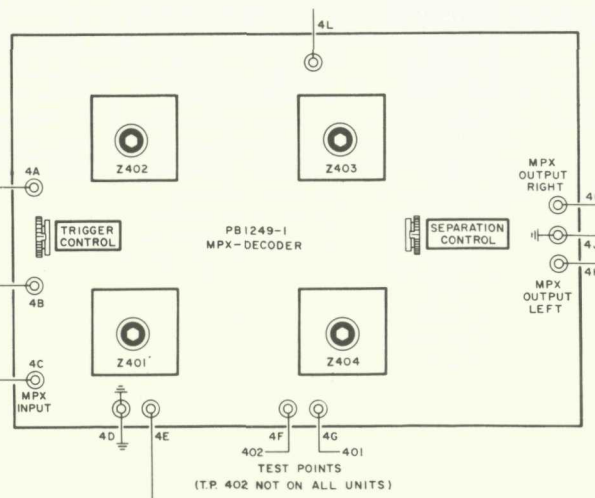

**CAPACITORS**  
 10% tolerance for all fixed capacitors, unless otherwise noted or marked GMV (guaranteed minimum value). All capacitors not marked uF are pF (uF).

Symbol	Description	Part No.
C401	†Ceramic, 68, 5%, N220	C50568-5
	*Ceramic, 220, 5%, N1500	C50568-6
C402	Mica, Silver, 4700, 5%, 100VDC	C50571-2
C403	Mylar, 0.1uF, 20%, 250V	C50635-1
C404	Polystyrene, 4700, 5%, 33V	C50636-23
C405	Mylar, .022uF, 100V	C50574-7
C406	Ceramic, 15, P100, 1000V	C50568-14
C407	Electrolytic, 4uF, 35V	C50483-1
C408	Polystyrene, 4700, 5%, 33V	C50636-23
C409	Mylar, 0.1uF, 20%, 250V	C50635-1
C410	Polystyrene, 220, 5%, 33V	C50636-3
C411	Mylar, .015uF, 100V	C50574-2
C412	Electrolytic, 1uF, 70V	C50483-16
C413	Polystyrene, 4700, 5%, 33V	C50636-23
C414, 415	Polystyrene, 330, 5%, 33V	C50636-4
C416, 417	Mylar, .01uF, 5%, 100V	C50574-1
C418, 419	Polystyrene, 910, 5%, 33V	C50636-6
C420, 421	Mylar, .01uF, 5%, 100V	C50574-1

C422, 423	Electrolytic, 4uF, 35V	C50483-1
C424	Polystyrene, 120, 5%, 33V	C50636-8
†	Used on PB1249-1 Board—(Tube-type IF Amplifiers)	
*	Used on PB1249-2 Board—(Transistor-type IF Amplifiers)	

**RESISTORS AND POTENTIOMETERS**  
 Deposited Carbon, in ohms, 5% tolerance, 1/8-watt, unless otherwise noted. K=Kilohms, M=Megohms.

Symbol	Description	Part No.
R401	Potentiometer, Trimmer, 250K, ±30%	R50694-4
R402	Composition, 1K, 10%, 1/2 W	RC20BF102K
R403	270K	R12DC274J
R404	150	R12DC151J
R405	39K	R12DC393J
R406	1.2K	R12DC122J
R407	470	R12DC471J
R408	330K	R12DC334J
R409	33K	R12DC333J
R410	390	R12DC391J
R411	10K	R12DC103J
*R412	15K	R12DC153J
R413, 414	470K	R12DC474J

R415, 416	68K	R12DC683J
R417, 418	4.7K	R12DC472J
R419, 420	560	R12DC561J
R421	Trimmer, 25K, ±30%, Separation Control	R50694-2
R422, 423	2.7K	R12DC272J
R424	22K	R12DC223J

**MISCELLANEOUS**

Symbol	Description	Part No.
CR401, 402	Diode, V1112	V1112
CR403	Ring Demodulator	V50260-29
L401	Coil, 20mH	L50334-2
L402, 403	Coil, 20mH	L50334-6
Q401	Transistor, 2N2924	TR2N2924-18
Q402, 403	Transistor, 2N2614	TR2N2614
Q404	Transistor, TI 417	TR9100-18
Q405, 406	Transistor, 2N2924	TR2N2924-18
PC401	Printed Circuit	PC50B187-21
Z401	Transformer, 19Kc	ZZ50210-63
Z402	Transformer, 19Kc	ZZ50210-67
Z403	Transformer, 19Kc	ZZ50210-64
Z404	Transformer, 38Kc	ZZ50210-65

# 1249 MULTIPLEX DECODER

## MULTIPLEX DECODER TESTS

- Modulate FM generator with 19 kc,  $\pm 6.5$  kc deviation. (Use external modulation if necessary.)
- Connect the FM generator output to the antenna terminals of the unit under test.
- With the FM generator set for an output of 25  $\mu$ V at the antenna terminals the stereo indicator should light up. If the generator output is reduced to 5  $\mu$ V, at the antenna terminals, the indicator light should remain ON.
- Reduce FM generator output to zero and the indicator light should go OFF.
- If the stereo indicator light does not respond properly to the tests above, readjust the trigger control (R401) until the stereo indicator lamp just turns ON with a 4  $\mu$ V signal applied to the antenna terminals.

## PREFERRED ALIGNMENT INSTRUCTIONS

(Using multiplex generator with RF and 19 kc outputs and with 1 kc modulation)

In Table 1, below, a multiplex generator with an RF output is used. This is the better method of alignment since the multiplex circuitry is connected to the tuner with which it will be used. Check the alignment of the IF stages before making multiplex adjustments. Poor IF alignment can make proper multiplex operation impossible.

This table is based on the FISHER Model 300 multiplex generator. Another alignment procedure, for MPX generators without an RF output, is shown in Table 2.

**TEST EQUIPMENT:** Multiplex Generator, Audio (AC) Vacuum-Tube Voltmeter (RMS type preferred), Vacuum-Tube Voltmeter (DC VTVM), Oscilloscope (100 kc minimum) with external sweep input.

**WARNING:** Use only the proper alignment tool to prevent core breakage.

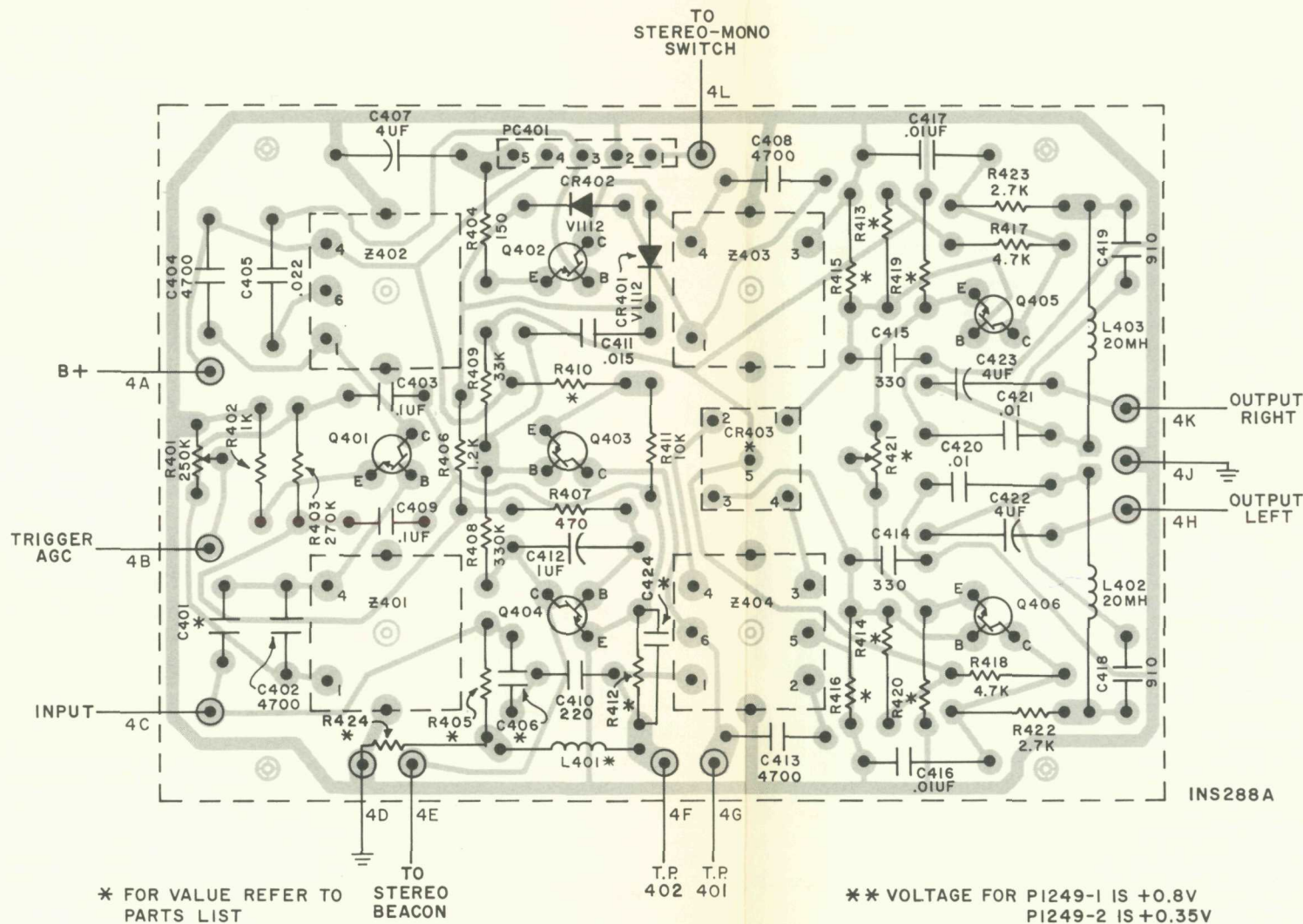

\* FOR VALUE REFER TO PARTS LIST

TO STEREO BEACON

\*\* VOLTAGE FOR P1249-1 IS +0.8V  
P1249-2 IS +0.35V

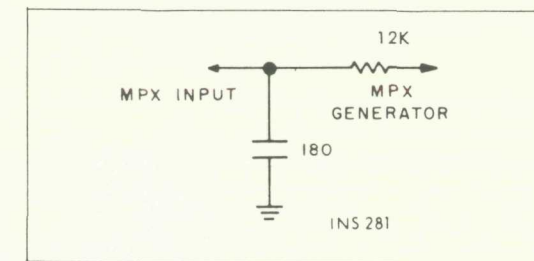
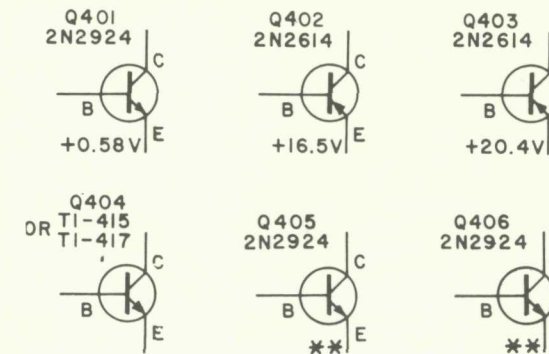

FIGURE 1. Multiplex-alignment pass filter circuit.

## ALTERNATE ALIGNMENT INSTRUCTIONS

(For multiplex generators without an RF output)

Disconnect the ratio detector from the multiplex unit before using this procedure. A low-pass filter (Figure 1) is used between the MPX generator output and the input to the multiplex circuitry. It has about the same loading effect as the output of the ratio detector in the tuner.

MULTIPLEX-GENERATOR RF OUTPUT CONNECTED TO ANTENNA TERMINALS

STEP	GENERATOR MODULATION	RF DEV.	INDICATOR TYPE AND CONNECTION	ALIGNMENT	
				ADJUST	INDICATION
1	70 to 76 kc (connect external audio generator to SCA input of multiplex generator.)	$\pm 25$ kc	Audio (AC) VTVM input to TP402 with a 10 pF capacitor in series with lead.	--	Read minimum AC voltage between 70 and 76 kc.
2	19 kc pilot only	$\pm 6.5$	DC VTVM to TP401	Z401, 402, 403 and 404	Maximum AC voltage (38 kc)
3	Composite MPX signal 1 kc on left channel only	$\pm 75$ kc	Audio (AC) VTVM and oscilloscope vertical input to left channel output lug (4H)	Z402	Maximum AC voltage with clean 1 kc sine wave on oscilloscope
4	Composite MPX signal 1 kc on right channel only	$\pm 75$ kc	Same as Step 3	MPX Separation Control (R421)	Minimum reading on Audio (AC) VTVM--should be at least 35db below reading obtained in Step 3.
5	Same as Step 4	$\pm 75$ kc	Audio (AC) VTVM and oscilloscope vertical input to right channel output lug (4K)	--	Same Audio (AC) VTVM reading as obtained in Step 3 ( $\pm 2$ db); clean 1kc sine wave on scope.
6	Same as Step 4	$\pm 75$ kc	Same as Step 5	--	Minimum reading on Audio (AC) VTVM should be at least 35db below reading in Step 5.

COMPOSITE OUTPUT OF MULTIPLEX GENERATOR CONNECTED TO INPUT OF MPX DECODER THROUGH LOW-PASS FILTER

STEP	GENERATOR MODULATION	LEVEL (RMS)	INDICATOR TYPE AND CONNECTION	ALIGNMENT	
				ADJUST	INDICATION
1	70 to 76 kc.	100mV	Audio (AC) VTVM input to TP402 with a 10 pF capacitor in series with lead.	--	Read minimum AC voltage between 70 and 76 kc.
2	19 kc pilot only	50mV	DC VTVM to TP401	Z401, 402, 403 and 404	Maximum AC voltage (38 kc)
3	Composite MPX signal 1 kc on left channel only	300mV	Audio (AC) VTVM and oscilloscope vertical input to left channel output lug (4H)	Z402	Maximum AC voltage with clean 1 kc sine wave on oscilloscope
4	Composite MPX signal 1 kc on right channel only	300mV	Same as Step 3	MPX Separation Control	Minimum reading on Audio (AC) VTVM--should be at least 35db below reading obtained in Step 3.
5	Same as Step 4	300mV	Audio (AC) VTVM and oscilloscope vertical input to right channel output lug	--	Same Audio (AC) VTVM reading as obtained in Step 3 ( $\pm 2$ db); clean 1kc sine wave on scope.
6	Same as Step 4	300mV	Same as Step 5	--	Minimum reading on Audio (AC) VTVM should be at least 35db below reading obtained in Step 5.

## COMPONENT CONNECTION

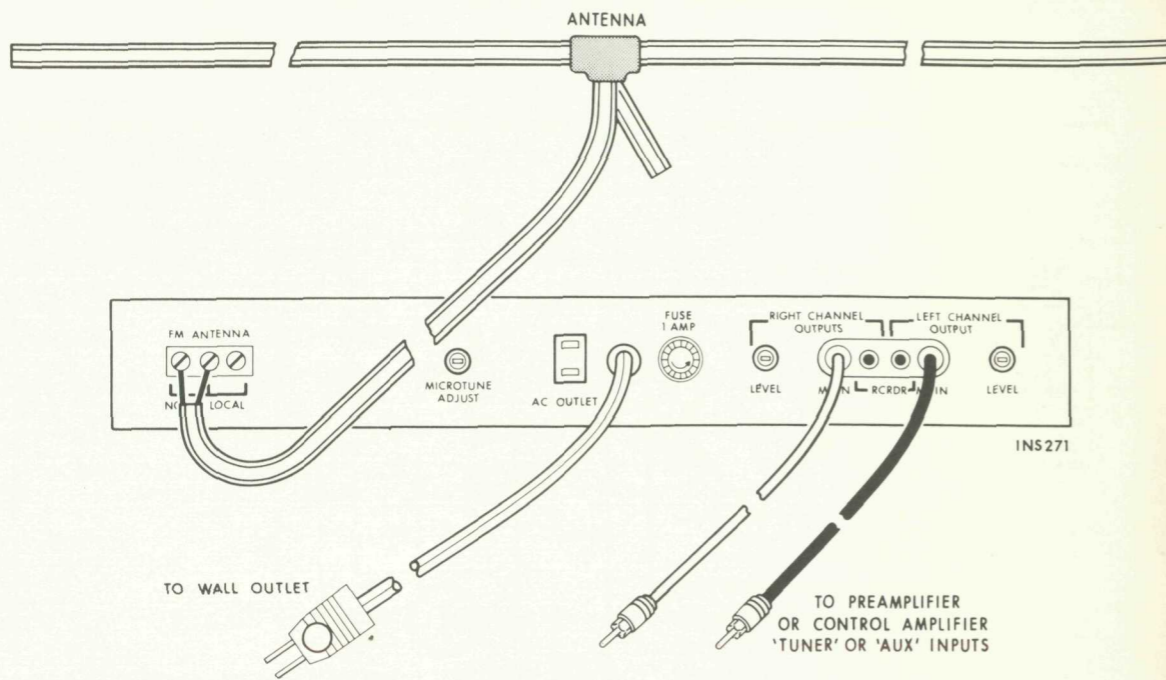

## TUNER MAINTENANCE

### CLEANING THE DIAL GLASS

(1) Remove the front panel: Disconnect the set from AC power as a precaution. Remove all knobs, and remove the hex nuts on the shafts of the Muting switch and Tuning control. Lift off the front panel.

(2) Loosen the screws that retain the clips to the dial glass. (When you replace the dial glass, make certain to reset it by placing it firmly against the lower left-hand corner.) Swing the retaining clips aside, and carefully lift off the dial glass.

(3) Remove dust with a dry rag. If you wish to clean more thoroughly, use a soap and water solution only; if you use any stronger cleaning agent, you may damage the markings on the glass.

### REPLACING DIAL LAMPS

First, disconnect the AC power cord as a precaution. Remove the front panel as described above. The lamps are held in place by spring clips and can be removed with the fingers. Replace with a new lamp from your FISHER Dealer (Part Number I-50441-1).

### DIAL-POINTER LAMP REPLACEMENT

(1) Disconnect AC power cord for safety.

(2) Remove front panel and dial glass as instructed in paragraph on cleaning the dial glass.

(3) Remove dial-pointer lamp wires from the small hook clip on the rear of the pointer base. (See dial pointer detail) and disconnect the leads from the pin connectors on the chassis.

(4) Remove the dial pointer (lamp plus metal guard), by sliding it directly downward, as shown.

(5) Install new dial-pointer assembly (Part No. AS 50451-2) upward, while pressing downward on the pointer base, until the pointer reaches its lower limit. The tab on the pointer should mate with the slot on the pointer base.

(6) Twist the two wires together and replace them in the hook clip on the back of the pointer base. DO NOT leave any slack in the wire under the pointer.

(7) Connect the ends of the two wires by pushing the connectors onto the pins mounted on the terminal strip on the chassis.

(8) Replace the dial glass and front panel.

### REPLACING FUSES

**Power Fuse** — The tuner is fused to protect it against line surges and other adverse conditions sometimes encountered by electronic equipment. If the tuner appears to be inoperative, check to see if the dial lamps light when the Power switch is turned ON. If the lamps do not light, the unit may have a blown power fuse. To replace the fuse, which is located in a black receptacle labelled in the center of the rear panel, proceed as follows:

1. Turn the Power switch to the OFF position.
2. Disconnect the power cord from the wall receptacle.
3. Push the cap of the fuseholder in, and turn it counter-clockwise. The cap will disengage, and you can pull it out, with the fuse remaining in its clip. Replace the fuse with a 1-ampere fuse only. Return the cap and fuse to the receptacle, reconnect the power plug, and turn the Power switch ON.

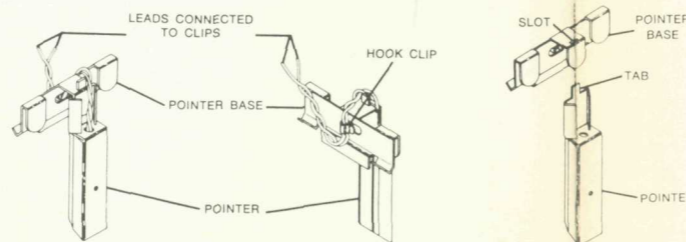

Illuminated dial pointer assembly

## 1249 MULTIPLEX MODIFICATION (for early production runs).

In some reception areas the possibility of an audible interference exists when a stereophonic station simultaneously transmitting an SCA (background music) signal is received.

To fully eliminate this possibility in the aforementioned models, a change in the existing SCA filter circuits on the Multiplex-Decoder Printed Circuit Board (P-1249) should be made, as outlined below.

Fisher Radio has prepared a package (Part No. SCA) of the few small parts required for this change, which can be performed easily by a service station or a dealer. Alignment is not required.

Refer to the photograph of the MPX adaptor board. The parts to be changed are indicated. Please note that some previous parts differ in value

Radd 22k

This is an addition

C406 was 56pf or 82pf

Must be 15pf

C410 was 820pf

Must be 220 pf

R405 was 39k or 56k

Must be 39k

Cadd 120pf parallel with 15k (R412)

120 pf is an addition

R412 was 6.8k or 8.2k

Must be 15k paralleled with 120pf (Cadd)

L401 was 5.3mh

Must be 20mh

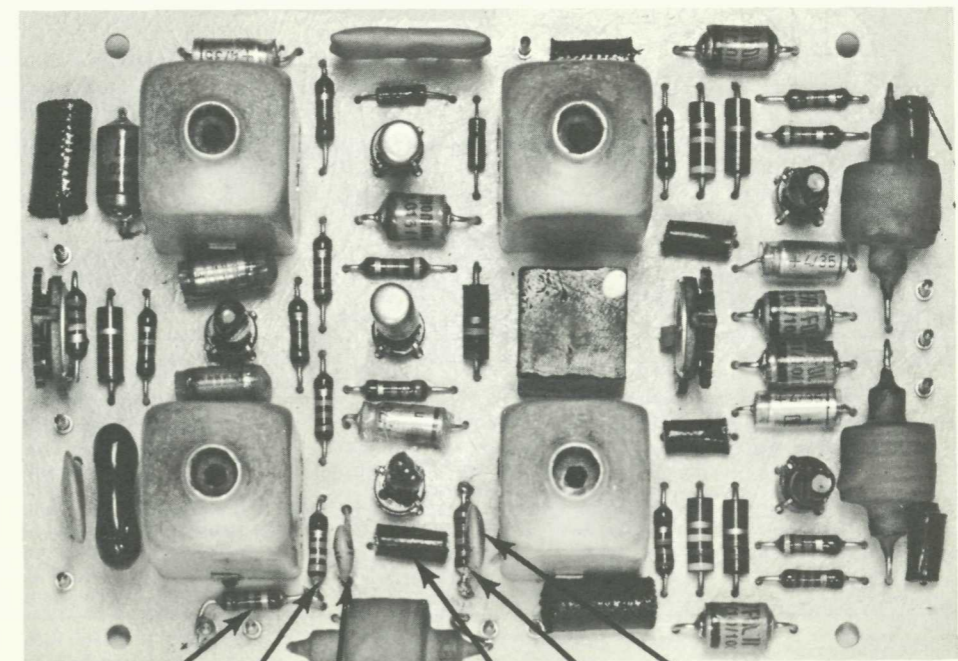

Radd R405 C406 L401 C410 R412 Cadd

# MAIN CHASSIS

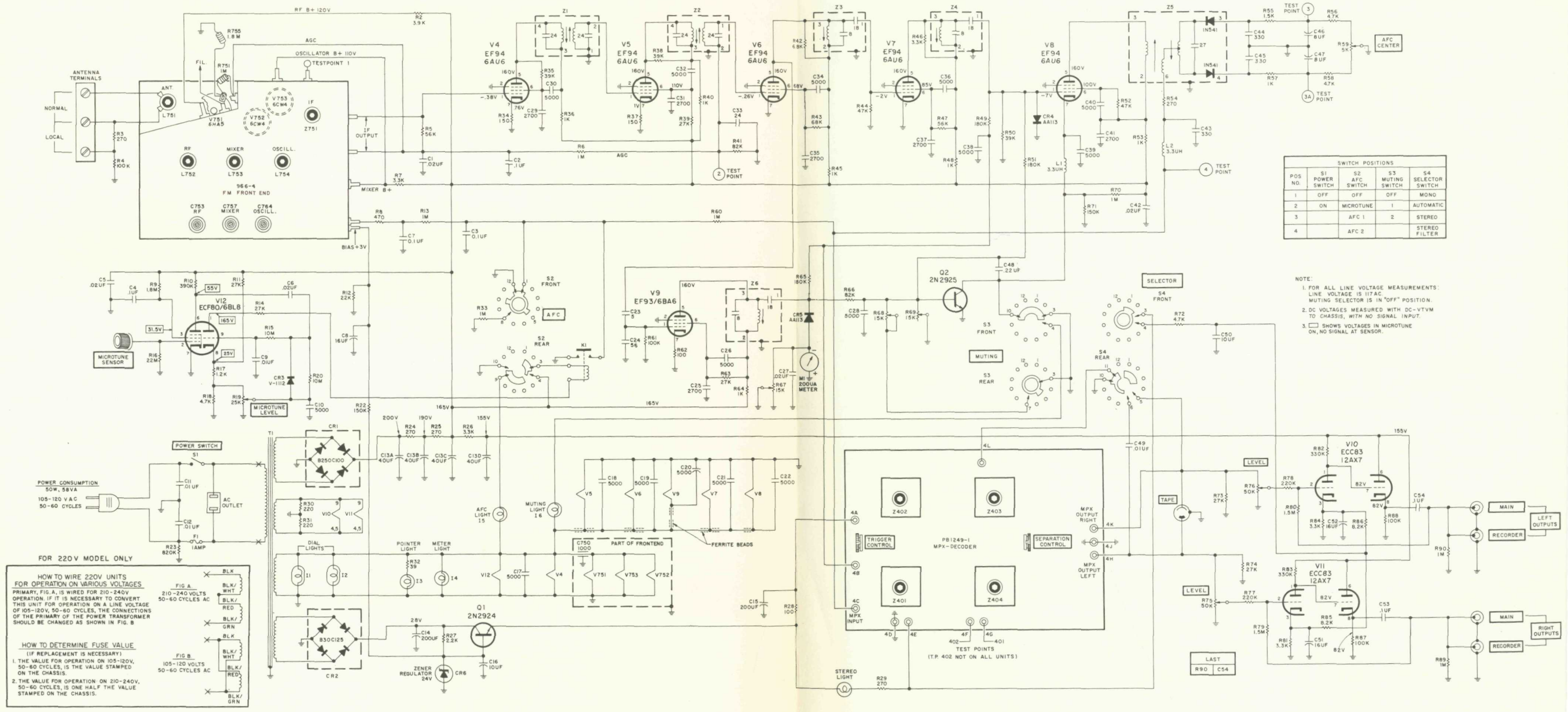

SWITCH POSITIONS				
POS. NO.	S1 POWER SWITCH	S2 AFC SWITCH	S3 MUTING SWITCH	S4 SELECTOR SWITCH
1	OFF	OFF	OFF	MONO
2	ON	MICROTUNE	1	AUTOMATIC
3		AFC 1	2	STEREO
4		AFC 2		STEREO FILTER

NOTE:  
 1. FOR ALL LINE VOLTAGE MEASUREMENTS, LINE VOLTAGE IS 117AC. MUTING SELECTOR IS IN "OFF" POSITION.  
 2. DC VOLTAGES MEASURED WITH DC-VTVM TO CHASSIS, WITH NO SIGNAL INPUT.  
 3.   SHOWS VOLTAGES IN MICROTUNE ON, NO SIGNAL AT SENSOR.

**FOR 220V MODEL ONLY**

**HOW TO WIRE 220V UNITS FOR OPERATION ON VARIOUS VOLTAGES**  
 PRIMARY, FIG. A, IS WIRED FOR 210-240V OPERATION. IF IT IS NECESSARY TO CONVERT THIS UNIT FOR OPERATION ON A LINE VOLTAGE OF 105-120V, 50-60 CYCLES, THE CONNECTIONS OF THE PRIMARY OF THE POWER TRANSFORMER SHOULD BE CHANGED AS SHOWN IN FIG. B

**HOW TO DETERMINE FUSE VALUE**  
 (IF REPLACEMENT IS NECESSARY)  
 1. THE VALUE FOR OPERATION ON 105-120V, 50-60 CYCLES, IS THE VALUE STAMPED ON THE CHASSIS.  
 2. THE VALUE FOR OPERATION ON 210-240V, 50-60 CYCLES, IS ONE HALF THE VALUE STAMPED ON THE CHASSIS.

BECAUSE ITS PRODUCTS ARE SUBJECT TO CONTINUOUS IMPROVEMENT, FISHER RADIO CORPORATION RESERVES THE RIGHT TO MODIFY ANY DESIGN OR SPECIFICATION WITHOUT NOTICE AND WITHOUT INCURRING ANY OBLIGATION.

## CAPACITORS

10% Tolerance for all fixed capacitors, unless otherwise noted or marked GMV (guaranteed minimum value). All Capacitors not marked uF are pF (uF).

Symbol	Description	Part No.
C1	Ceramic, .02uF +80-20%, 100V	C50095-1
C2	Mylar, .1uF, 20%, 250V	C50633-1
C3, 4	Mylar, .1uF, 20%, 250V	C50B575-1
C5	Ceramic, .02uF, GMV, 1000V	C50071-6
C6	Ceramic, .02uF, 20%	C50089-5
C7	Mylar, .1uF, 20%, 250V	C50633-1
C8	Electrolytic, 16uF, 10V	C50483-10
C9	Ceramic, .01uF, 20%, 500V	C50089-3
C10	Ceramic, 5000 +80-20%, 500V	C50089-6
C11, 12	Molded, .01uF, 20%, 600V	C2747
C13	Electrolytic, 4-Section A-40uF, 300V B-40uF, 300V C-40uF, 250V D-40uF, 250V	C670-125B
C14, 15	Electrolytic, 200uF, 35V	C50483-7
C16	Electrolytic, 10uF, 35V	C50483-2
C17, 18, 19		
20, 21, 22	Ceramic, 5000 +80-20%, 500V	C50089-6
C23	Ceramic, 5, NPO, 1000V	C50070-24
C24	Ceramic, 56, N1500, 1000V	C50070-22
C25	Ceramic, 2700, 1000V	C50072-17
C26	Ceramic, 5000, +80-20%, 500V	C50089-6
C27	Ceramic, .02uF, 20%, 500V	C50089-5
C28	Ceramic, 5000, +80-20%	C50089-6
C29	Ceramic, 2700, 1000V	C50072-17
C30	Ceramic, 5000, +80-20%, 500V	C50089-6
C31	Ceramic, 2700, 1000V	C50072-17
C32	Ceramic, 5000, +80-20%, 500V	C50089-16
C33	Ceramic, 24, 5%, N150, 1000V	C50070-8
C34	Ceramic, 5000, +80-20%, 500V	C50089-6
C35	Ceramic, 2700, 1000V	C50072-17
C36	Ceramic, 5000, +80-20%, 500V	C50089-6
C37	Ceramic, 2700, 1000V	C50072-17
C38, 39, 40	Ceramic, 5000, +80-20%, 500V	C50089-6
C41	Ceramic, 2700, 1000V	C50072-17
C42	Ceramic, .02, GMV, 1000V	C50071-6
C43, 44, 45	Ceramic, 330, 1000V	C50072-1
C46, 47	Electrolytic, 8uF, 50V	C629-138
C48	Mylar, .22uF, 20%, 250V	C50575-3
C49	Mylar, .01uF, 5%, 100V	C50574-1
C50	Electrolytic, 10uF, 35V	C50483-2
C51, 52	Electrolytic, 16uF, 10V	C50483-10
C53, 54	Mylar, .1uF, 20%, 250V	C50575-1

## RESISTORS

Deposited Carbon in ohms, 5% tolerance, 1/8-watt, unless otherwise noted. K=Kilohm, M=Megohm.

Symbol	Description	Part No.
R1	-Deleted-	-
R2	Composition, 3.9K, 10%, 1/2W	RC20BF392K
R3	Composition, 270, 10%, 1/2W	RC20BF271K
R4	Composition, 100K, 10%, 1/2W	RC20BF104K
R5	56K	R12DC563K
R6	1M	R12DC105J
R7	Composition, 3.3K, 10%, 1W	RC30BF332K
R8	470	R12DC471J
R9	Composition, 1.8M, 10%, 1/2W	RC20BF185K
R10	Composition, 390K, 10%, 1/2W	RC20BF394K
R11	Composition, 27K, 10%, 1W	RC30BF273K
R12	22K	R12DC223J
R13	1M	R12DC105J
R14	Composition, 27K, 10%, 1/2W	RC20BF273K
R15	Composition, 10M, 10%, 1/2W	RC20BF106K
R16	Composition, 22M, 10%, 1/2W	RC20BF226K
R17	Composition, 1.2K, 10%, 1/2W	RC20BF122K
R18	Composition, 4.7K, 10%, 1/2W	RC20BF472K
R19	Potentiometer, 25K, Level	R501032D
R20	Composition, 10M, 10%, 1/2W	RC20BF106K
R21	-Deleted-	-
R22	150K	R12DC154J
R23	Composition, 820K, 10%, 1/2W	RC20BF824K
R24, 25	Glass, 270, 10%, 3W	RP3W271K
R26	Composition, 3.3K, 10%, 1/2W	RC20BF332K
R27	2.2K	R12DC222J
R28	Composition, 100, 10%, 1/2W	RC20BF101K
R29	270	R12DC271J
R30, 31	Composition, 220, 10%, 1/2W	RC20BF221K
R32	Composition, 39, 10%, 1/2W	RC20BF390K
R33	1M	R12DC105J
R34	Composition, 150, 10%, 1/2W	RC20BF151K
R35	Composition, 39K, 10%, 1/2W	RC20BF393K
R36	Composition, 1K, 10%, 1/2W	RC20BF102K

R37	Composition, 150, 10%, 1/2W	RC20BF151K
R38	39K	R12DC393J
R39	Composition, 27K, 10%, 1/2W	RC20BF273K
R40	Composition, 1K, 10%, 1/2W	RC20BF102K
R41	82K	R12DC823J
R42	6.8K	R12DC682J
R43	Composition, 68K, 10%, 1/2W	RC20BF683K
R44	47K	R12DC473J
R45	Composition, 1K, 10%, 1/2W	RC20BF102K
R46	3.3K	R12DC332J
R47	Composition, 56K, 10%, 1/2W	RC20BF563K
R48	Composition, 1K, 10%, 1/2W	RC20BF102K
R49	180K	R12DC184J
R50	39K	R12DC393J
R51	180K	R12DC184J
R52	Composition, 47K	RC20BF473K
R53	1K	RC20BF102K
R54	270	R12DC271J
R55	1.5K	R12DC152J
R56	4.7K	R12DC472J
R57	1K	R12DC102J
R58	4.7K	R12DC472J
R59	Potentiometer, 5K, 30% AFC Adjust	R50694-5
R60	1M	R12DC105J
R61	100K	R12DC104J
R62	Composition, 100, 10%, 1/2W	RC20BF101K
R63	Composition, 27K, 10%, 1/2W	RC20BF273K
R64	Composition, 1K, 10%, 1/2W	RC20BF102K
R65	180K	R12DC184J
R66	82K	R12DC823J
R67, 68, 69	Potentiometer, Trimmer, 15K, 30%	R50694-1
R70	1M	R12DC105J
R71	150K	R12DC154J
R72	4.7K	R12DC472J
R73, 74	27K	R12DC273J
R75, 76	Potentiometer, 50K, Output Level	R50103-3D
R77, 78	220K	R12DC224J
R79, 80	Dep. Carbon, 1.5M, 5%, 1/3W	R33DC155J
R81	3.3K	R12DC332J
R82, 83	330K	R12DC334J
R84	3.3K	R12DC332J
R85, 86	8.2K	R12DC822J
R87, 88	Composition, 100K, 10%, 1/2W	RC20BF104K
R89, 90	1M	R12DC105J

## MISCELLANEOUS

Symbol	Description	Part No.
CR1	Rectifier, Selenium	SR50279-1
CR2	Rectifier, Selenium	SR950-149
CR3	Diode, Silicon	V50260-10
CR4, 5	Diode, Germanium AA113	J50260-22
CR6	Diode, Zener, Regulator	JZ50B793-3
F1	Fuse, 1A, Slo-Blo	F692-132
11, 12	Lamp, Dial	I50441-1
*13	Lamp, Pointer (part of assembly)	AS50451-3
13	Lamp, Pointer (part of assembly)	AS50451-5
14	Lamp, Meter #18470.F.	I50009-8
15, 6	Lamp, AFC, Muting	I50009-7
K1	Relay	K50314
L1, 2	Choke, 3.3 Microhenry	L50066-8
M1	Meter	M990-124
Q1	Transistor 2N2924	TR2N2924
Q2	Transistor	TR2N2925
S1	Switch, Power	S50358-7
S2	Switch, AFC	S1128-129
S3	Switch, Muting	S1128-130
S4	Switch, Selector	S1128-128
T1	Transformer, Power	T1128-115
Z2	Transformer, 1F	JZ50210-39
Z3	Transformer, 1F	JZ50210-2
Z4, 5	Transformer, Limiter	JZ50210-6
Z6	Transformer, Ratio Detector	JZ50210-9
-	Antenna, Dipole	AS50227-1
-	Nameplate Holder	A50557
-	Indicator Assembly, Muting	AS50538-1
-	Indicator Assembly, AFC	AS50538-2
-	Dress Panel	A1128-112
-	Insert, Dress Panel Screened (Upper)	AS1128-122
-	Insert, Dress Panel Screened (Lower)	AS1128-123
-	Knob, Selector, Muting, AFC Power	E50562-1
-	Knob, Tuning	E50566-2
-	Drive Wheel, Tuning Capacitor	E50588
-	Lampholder, Stereo Beacon	AS1128-140
-	Jack, Tape Recorder	J50545
-	Dial Glass	N1128-107
-	Nameplate Insert, (Bird)	N50591-1
-	Nameplate Insert, (Professional Series)	N50591-1

\* Serialization 10001 - 11000 only.



## TROUBLESHOOTING GUIDE

When a defect occurs in an electronic circuit the first component suspected is usually the vacuum tube. Many of the inexpensive tube testers will not indicate all the possible internal faults in a vacuum tube—slight defects often sneak past these testers. It is better to substitute another tube of the same type.

Sometimes it is possible to switch (transpose) tubes from one circuit to another. This method of testing is most suitable when testing and individual stereo channel. When a good tube is switched with a defective one of the same type the symptom will be transferred from one

stereo channel to the other.

When substituting tubes it is absolutely necessary to be certain the tube being inserted is good—a new tube, from a freshly opened carton, is not necessarily a perfect tube. Defects can occur from shipping and handling.

If you have any doubts about the quality of a tube try it in an identical circuit that is operating properly. For example, a tube with heater-cathode leakage may operate normally in a circuit with its cathode grounded; transpose (switch) it with one in a circuit that has a cathode-bias resistor and it will cause a lot of hum.

Does not go on (pilot or dial lamps do not light).

Check: Power switch S1, Fuse F1, AC power cord and AC outlet (use test lamp in rear-chassis AC outlet).

Distortion Hum or No audio output (any position of SELECTOR switch).  
Remove plug from front-panel TAPE jack. Remove plugs from RCRDR (recorder) jacks.

Check: Output LEVEL controls (R75, R76) or rear chassis. MUTING switch position—set to OFF. Antenna position and connections—tune for other stations. Interconnecting cables to amplifier.

Test: V751, V752, V753, V4, V5, V6, V7, V8, V9, V10, V11, V12. Voltage at C13A, R24, CR1; R24, R25, C13B; R25, R26, C13C; R26, C13D (AC ripple for hum). Voltage at CR2, C14, R27, Q1 (ripple for hum).

Distortion Hum or No audio output (any position of SELECTOR except MONO).

Check: Multiplex decoder. Output of CR2 (28-volt rectifier). Emitter voltage of Q1

Distortion Hum or No audio output (LEFT channel only) SELECTOR in MONO position.  
Remove plug from RCRDR jack. Remove plug from front-panel TAPE jack.

Check: Setting of LEFT output LEVEL control. Interconnecting cable, jacks and plugs.

Test: (filament leakage for hum) V10 or substitute.

Distortion Hum or No audio output (RIGHT channel only) SELECTOR in MONO position.  
Remove plug from RCRDR jack. Remove plug from front-panel TAPE jack.

Check: Setting of RIGHT output LEVEL control. Interconnecting cable, jacks and plugs.

Test: (filament leakage for hum) V11 or substitute.

MUTING does not work (positions 1 or 2 of MUTING switch). Tuning meter indicates.

Check: Setting of R69 (and R68).

Test: V8 for cathode short or leakage or substitute. Q2 or substitute.

TUNING METER and MUTING do not work.

Check: Setting of calibration control R67. Alignment of Z6.

Test: V9, CR5 or substitute.

AFC does not work (any position of AFC switch).

Check: Relay K1 for opening and closing. (remove V12 from socket). Setting of R59 AFC CENTER control.

TEST: V12, CR3 or substitute.

MICROTUNE does not work (AFC 1 and AFC 2 positions work).

Check: Relay K1 for opening and closing. Setting of R19.

Test: V12, CR3 or substitute.  
(chassis and antenna must not be grounded.)

## ALIGNMENT INSTRUCTIONS

**Read These Instructions With Extreme Care Before Attempting Alignment.**

**CHASSIS:** Turn the TUNING knob completely counterclockwise without forcing. Dial pointer should be at zero index mark on logging scale. If not, reset the dial pointer. Disconnect the external antenna. When using an oscilloscope for alignment, set the AUDIO LEVEL control for no overload, as shown by the proper waveform shape. Set remaining controls as follows: SELECTOR, MONO; MUTING, OFF; POWER, ON.

**SIGNAL GENERATOR:** The signal generator equipment must be able to supply RF  $\pm 22.5$  KC deviation at 400 cps.

**INDICATOR:** DC VTVM, and scope for alignment.

**ALIGNMENT:** Allow the chassis and test instruments to warm up for at least 15 minutes. Adjust the line voltage for 117 volts AC, 50-60 cps. Use fully insulated tools; a small screwdriver for all trimming capacitors.

**NOTES:**—For accurate alignment, signal generator output voltage must be adjusted to produce meter readings within the range specified in the INDICATION column for each step.

Signal generator frequency should be held constant for IF, limiter and ratio detector alignment.

Do not tamper with adjustments on multiplex sub-chassis. These circuits are extremely stable and should require no service other than tube replacement, which does not affect alignment. Multiplex alignment requires special equipment and procedures. We recommend the FISHER MPX-300 Multiplex Generator for all multiplex servicing applications.

### FM ALIGNMENT (Tuner Only)

Set AFC and MUTING switches to their OFF positions before starting alignment.  
Set R59 (AFC CENTER) to the mechanical center of its rotation.

STEPS	CHASSIS	SIGNAL GENERATOR			INDICATOR	ALIGNMENT	
	TUNING	COUPLING	FREQ.	MOD.	TYPE CONNECTION	ADJUST	INDICATION
1	Point of no signal and no interference	FM generator connected to TEST POINT 1 through 0.5 pF (or less), clipped to wire insulation or "gimmick"	10.7 MC	None	Connect DC VTVM to TEST POINT 2	Z751, Z1 and Z2 top and bottom for maximum indication	Between —2 and —5 volts
2	Point of no signal and no interference	FM generator to pin 1 of V6	10.7 MC	None	Connect DC VTVM between TP3 and TP3A	Z3 and Z4 bottom; Z5 top & bottom	Between 15 and 20 volts
3	Point of no signal and no interference	FM generator to pin 1 of V6	10.7 MC	None	Tuning Indicator	Z6 bottom for maximum indication	Between 2 & 4 on tuning indicator scale
4	Point of no signal and no interference	FM generator to pin 1 of V6	10.7 MC	None	Connect DC VTVM to TEST POINT 4	Z5 top	Zero volts — between negative and positive swing
5	90 MC	FM generator connected to NORMAL terminals through 120 ohm carbon resistors	90 MC	30% FM (22.5 KC Dev.) at 400 cps.	DC VTVM to test point 2 and scope to RIGHT or LEFT OUTPUT jack	L754, L753 and L752 for sinusoidal waveform & max. neg. volt.	Less than —4 volts
6	106 MC	FM generator connected to NORMAL terminals through 120 ohm carbon resistors	106 MC	30% FM (22.5 KC Dev.) at 400 cps.	DC VTVM to test point 2 and scope to RIGHT or LEFT OUTPUT jack	C764, C757 and C753 for sinusoidal waveform & max. neg. volt.	Less than —4 volts
7	98 MC	FM generator connected to NORMAL terminals through 120 ohm carbon resistors	98 MC	30% FM (22.5 KC Dev.) at 400 cps	DC VTVM to TP2 & Scope to RIGHT or LEFT OUTPUT jack	L751 for sinusoidal waveform and max. meg. volt.	Less than —4 volts
8	Repeat steps 5, 6 and 7 for proper dial calibration and maximum output.						

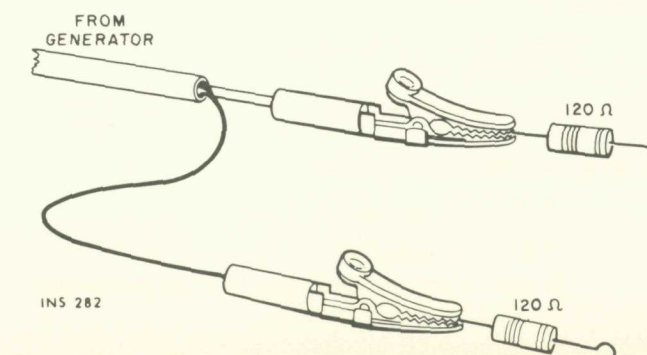

# CHASSIS LAYOUT

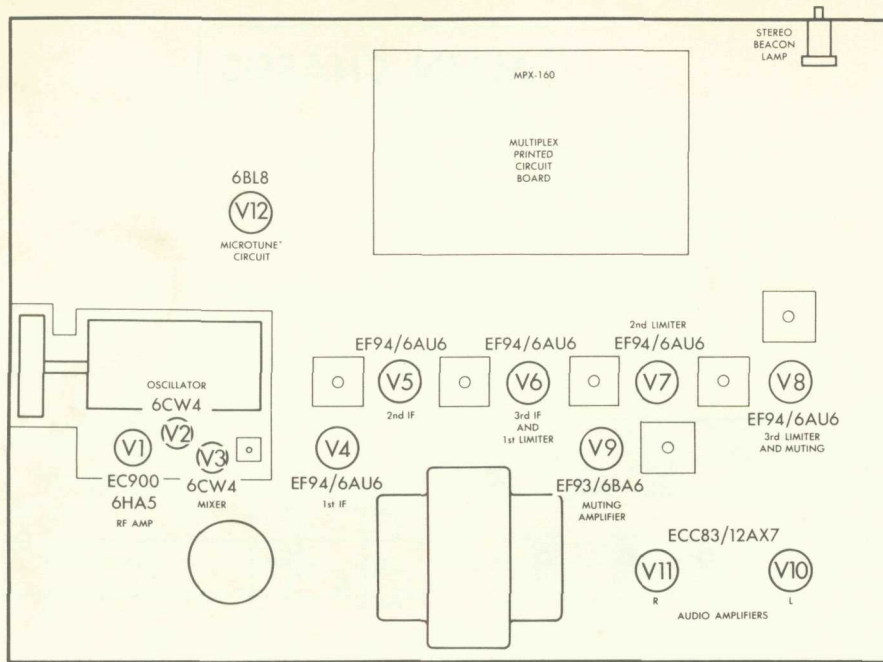

1NS270

## DIAL STRINGING PROCEDURE

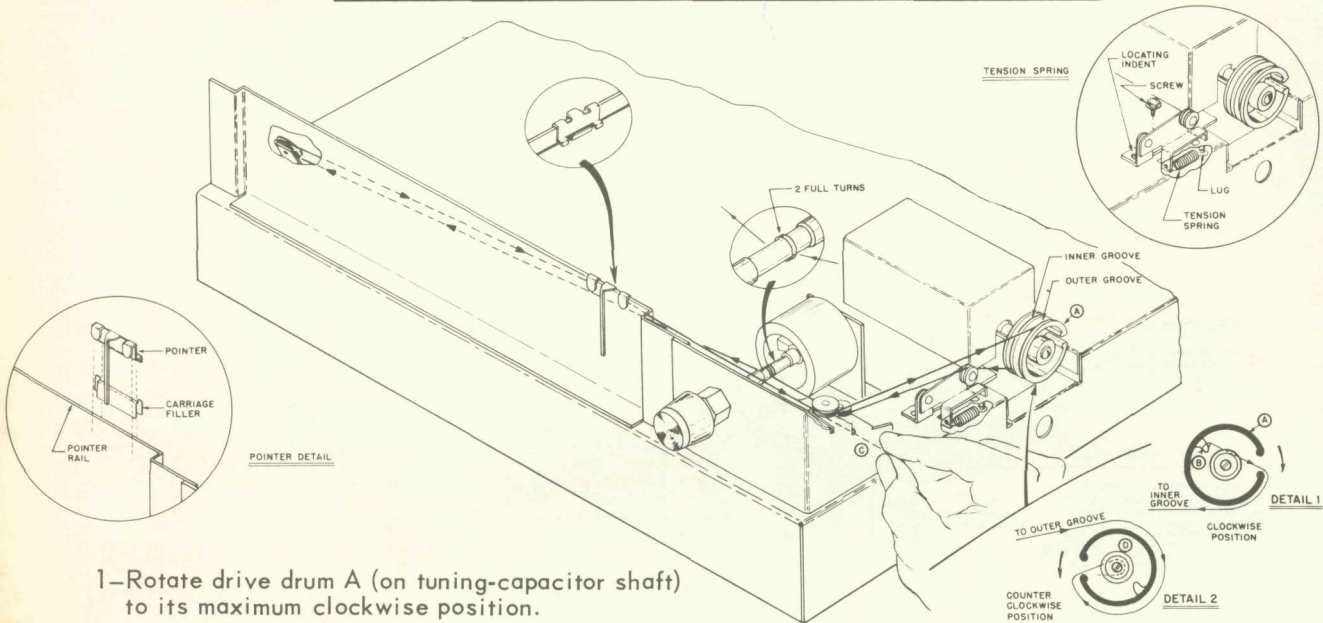

- 1—Rotate drive drum A (on tuning-capacitor shaft) to its maximum clockwise position.
- 2—Tie dial cord to ear B (inside drum A) as shown in Detail 1.
- 3—Run dial cord through slot in rim of drum A.
- 4—Set dial cord in INNER groove and over tension-spring pulley.
- 5—String dial cord, as shown, to point C.
- 6—Hold dial cord taut with left hand.

- 7—Wind drum A to maximum counterclockwise position (with right hand).
- 8—Wrap loose end of dial cord around drum A, in outer groove, as shown in Detail 2 (using right hand).
- 9—Secure loose end of dial cord under machine screw and washer (D) in the center of the drive drum.



FISHER RADIO CORPORATION • NEW YORK

